

The description and use of the Pores in the skin of the hands and feet, by the learned and ingenious Nehemiah Grew, M. D. fellow of the College of Physicians and of the Royal Society.

BY *Pores*, *Physicians* mean no more, than certain permeable spaces between the parts of a Body. Wherefore, that there are *Pores* in the skin of every man's Body, is no more to be question'd, than whether Men do ever sweat or perspire.

But in the *Hands* and *Feet*, they are very remarkable; both in respect of their *Position* and their *Amplitude*, hitherto, so far as I know, describ'd by no *Anatomist*.

For if any one will but take the pains, with an indifferent *Glass*, to survey the *Palm* of his *Hand* very well wash'd with a *Ball*; he may perceive (besides those great *Lines* to which some men have given Names, and those of a middle size call'd the *Grain* of the skin) innumerable *little Ridges*, of equal bigness and distance, and every where running parallel one with another. And especially, upon the ends and first *Joynts* of the *Fingers* and *Thumb*, upon the top of the *Ball*, and near the root of the *Thumb* a little above the *Wrist*. In all which places, they are very regularly dispos'd into *spherical Triangles*, and *Ellipticks*; as in the *Hand* I have caus'd to be drawn *Fig. 1.* Upon these *Ridges* stand the *Pores*, all in even *Rows*, and of that magnitude, as to be visible to a very good *Eye* without a *Glass*. But being view'd with one, every *Pore* looks like a little *Fountain*, and the sweat may be seen to stand therein, as clear as rock water, and as often as it is wip'd off, to spring up within them again.

That which *Nature* intends in the position of these *Ridges*, is, That they may the better suit with the use
and

and motion of the Hand: those of the lower side of every *Triangle*, to the bending in or clutching of the Fingers; and those of the other two sides, and of the *Ellipticks*, to the pressure of the Hand or Fingers ends against any body, requiring them to yield to the right and left. Upon these *Ridges*, the *Pores* are very providently placed, and not in the *Furrows* which lie between them; that so their structure might be the more sturdy, and less liable to be depraved by compression; whereby only the *Furrows* are dilated or contracted, the *Ridges* constantly maintaining themselves, and so the *Pores* unalter'd. And for the same reason, the *Pores* are also very large, that they may still be the better preserved, tho' the skin be never so much compressed and condens'd, by the constant use and labour of the Hand. And so those of the *Feet*, notwithstanding the compression of the skin by the weight of the whole Body.

These *Pores* being thus made and secur'd, are a very convenient and open passage for the discharge of the more noxious and perspirable parts of the *Blood*. Which by the continual use of the *Hands* and *Feet*, are plentifully brought into them. Whence it is, that the *sweat* of the *Feet*, in many people, is much more offensive than that of any other part of the *Body*. And that many *Hypochondriacal* Men, and *Hysterical* Women, have almost a continual burning in the soles of their *Feet*, and the *Palms* of their *Hands*. Yet not on the top of their *Feet* or back of their *Hands*; which being not so much chafed nor kept so warm, are the less disposed to receive the said noxious parts; and are therefore unfurnished with this kind of *Pores*.

Fig. 1.



Fig. 2.

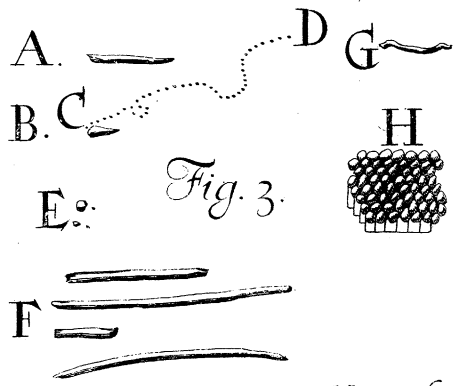
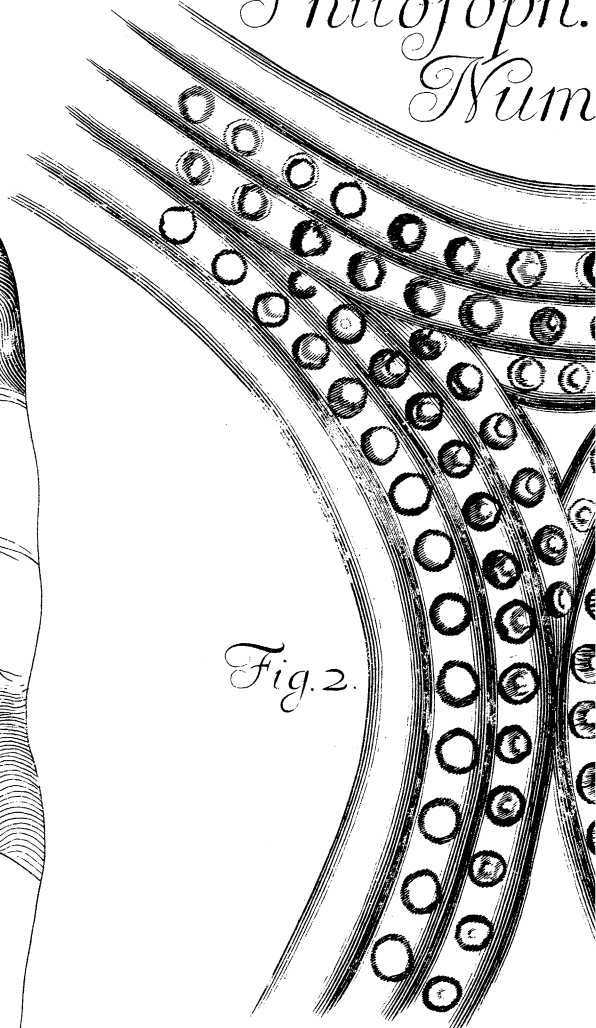

Fig. 3.

ph. Transact.
 Umb. 159.

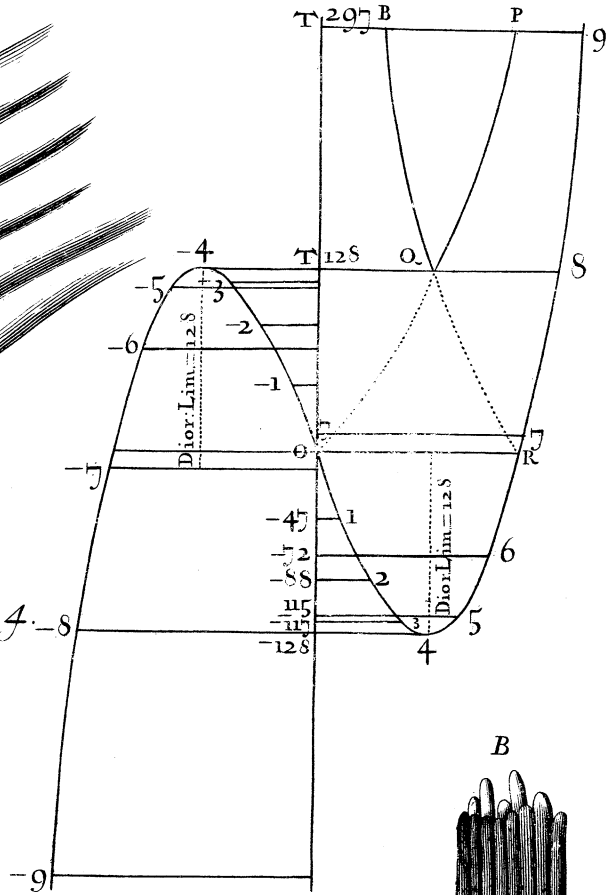
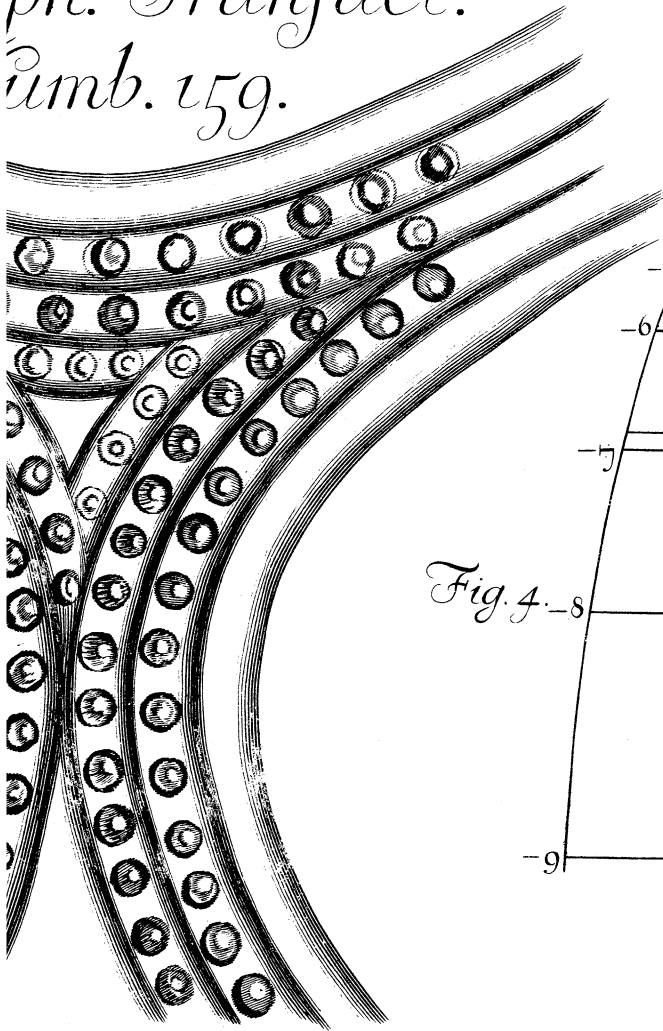
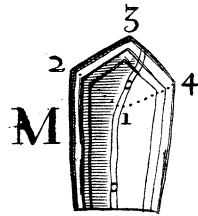
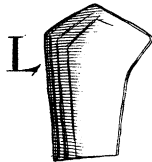
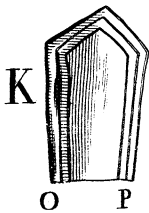
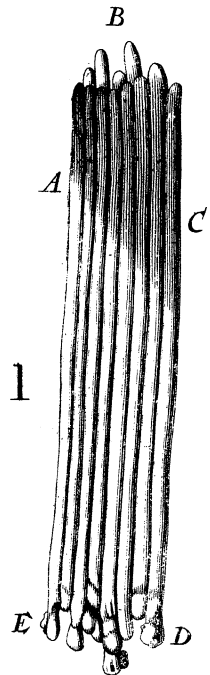

Fig. 4.



sculp.